

Montagescheiben / Mounting pads

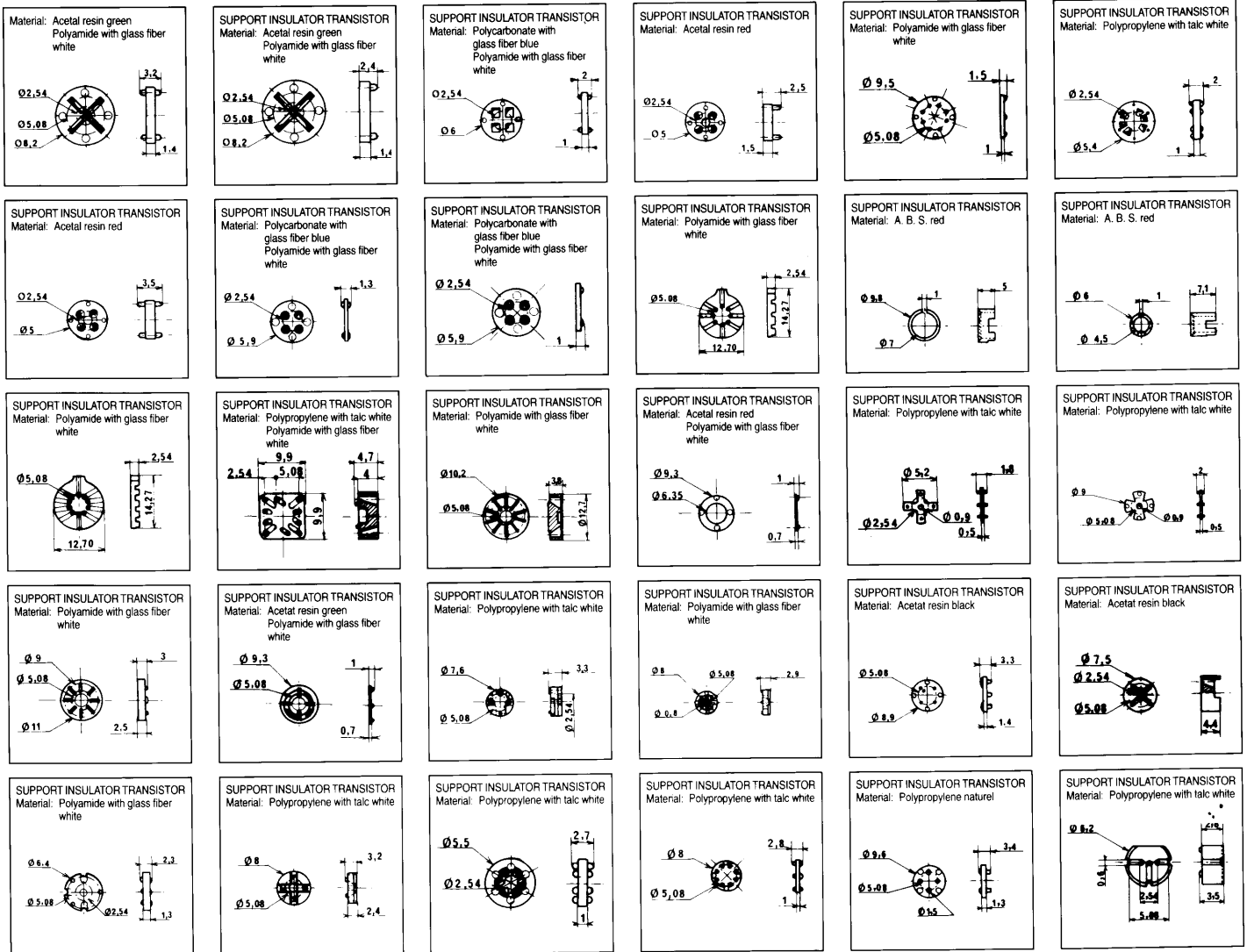

Montagescheiben

Mehrzwecktypen

Achtung: alle Maße in am. inch = 25.4 mm

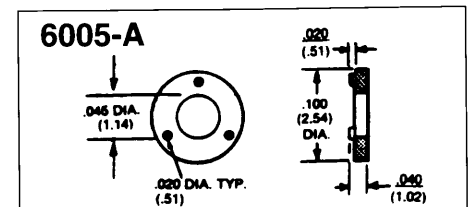
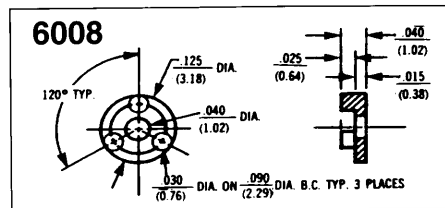
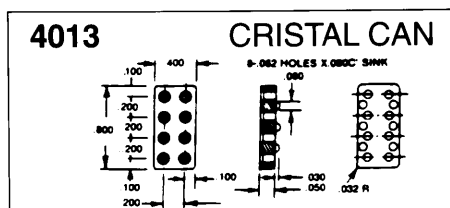
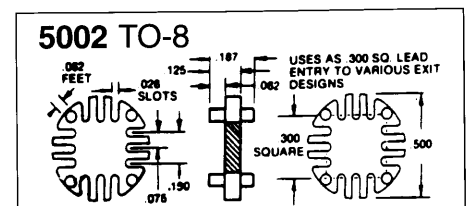
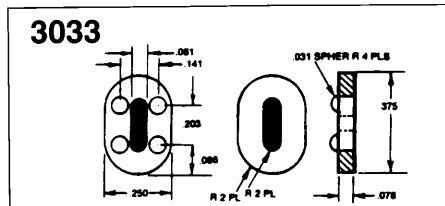
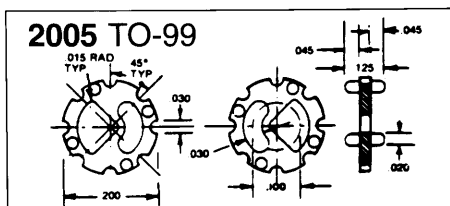



Montagescheiben für TO-18, Raster 25.4 mm

Achtung: alle Maße in am. inch = 25.4 mm

auch für TO-16, 26, 28, 46, 52, 54, 56, 58, 72, 104, 106, 107

und als Anschlußadapter für TO-7, 9, 11, 12, 16, 26, 29, 31, 32, 38, 39, 40, 43, 45, 55, 77, 78, 92, 98, 105

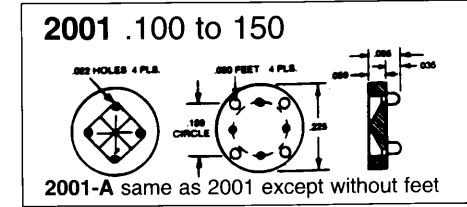
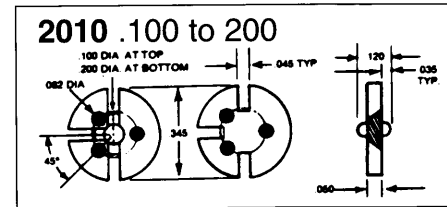
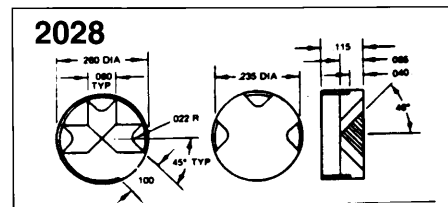
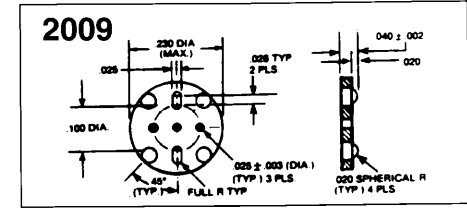
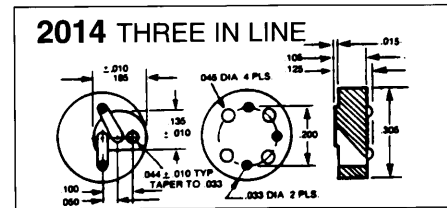
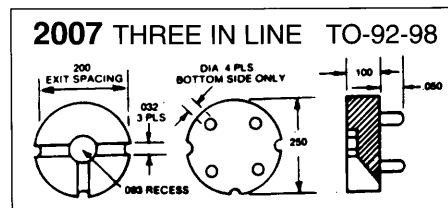
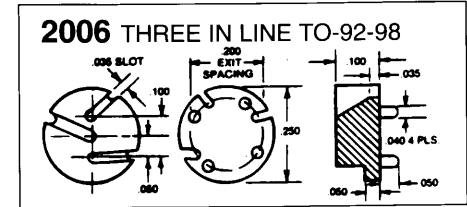
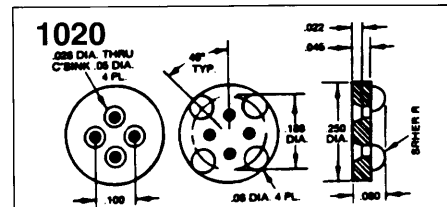
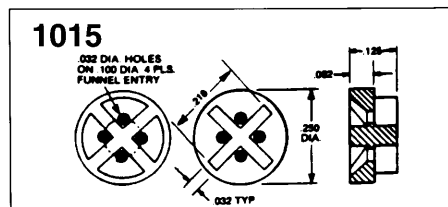
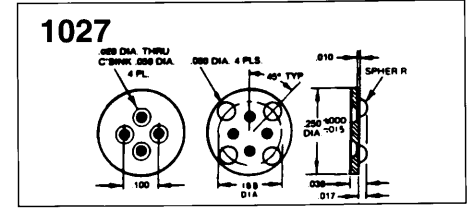
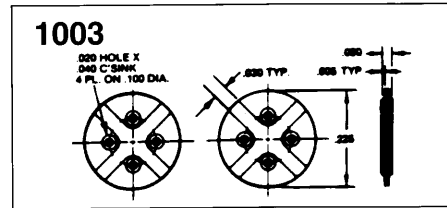
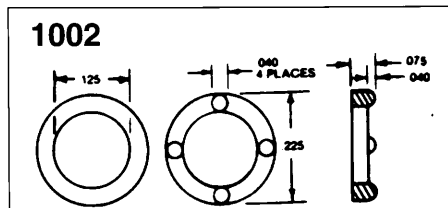
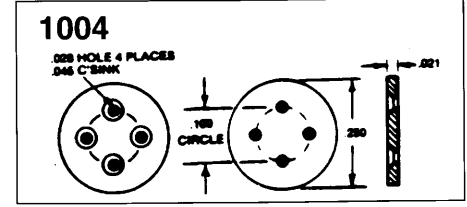
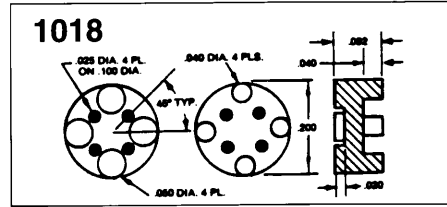
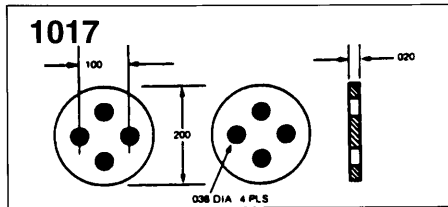
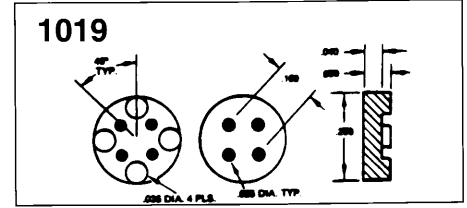
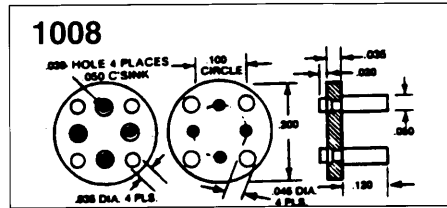
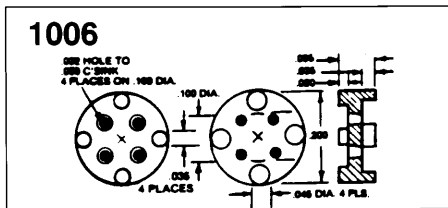
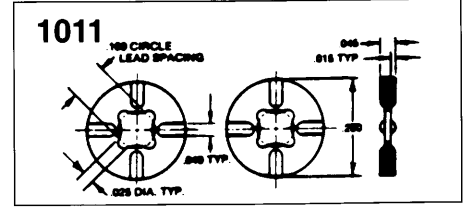
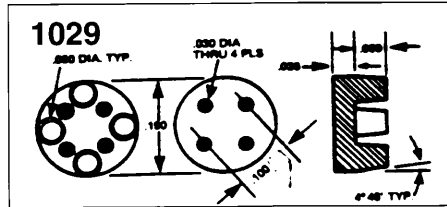
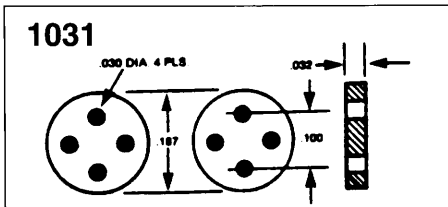
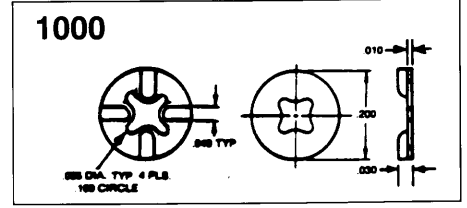
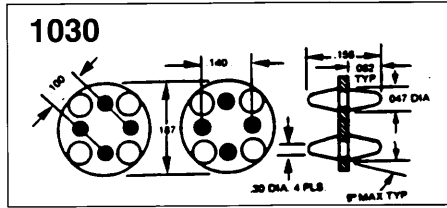
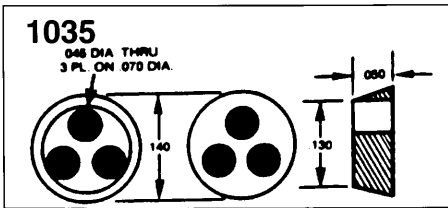

Fortsetzung nächste Seite



Montagescheiben für TO-18, Raster 25.4 mm

Fortsetzung

Achtung: alle Maße in am. inch = 25.4 mm

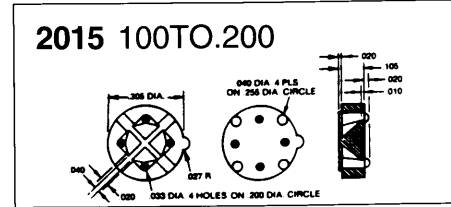
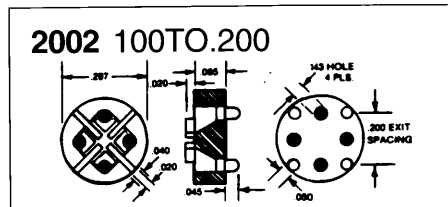
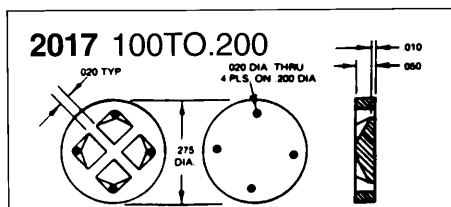
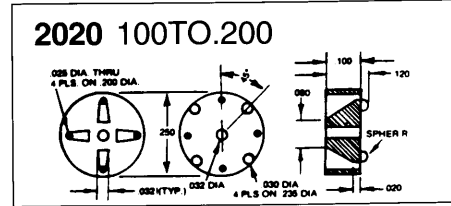
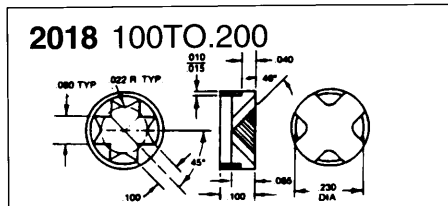
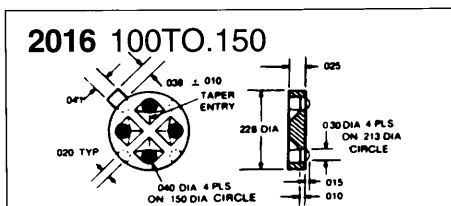

Montagescheiben für TO-5, Raster 25.4 mm

auch für TO-7, 9, 11, 12, 16, 26, 29 31, 32, 38, 39, 40, 43, 45, 55, 77, 78, 105

Achtung: alle Maße in am. inch = 25.4 mm

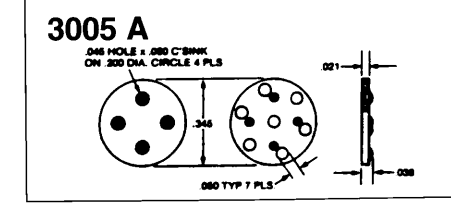
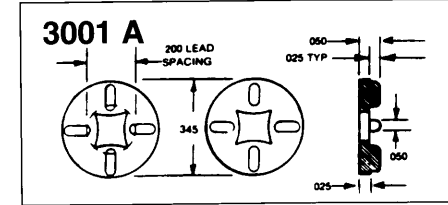
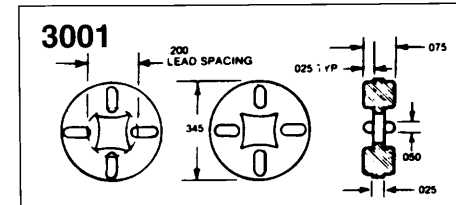
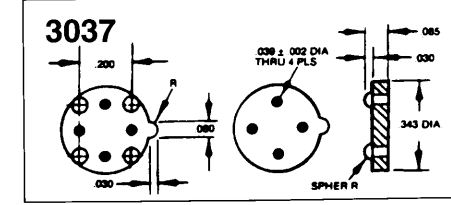
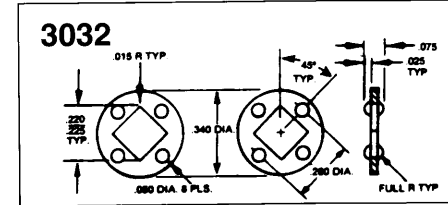
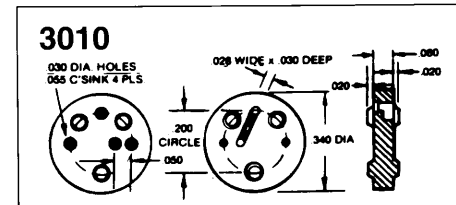
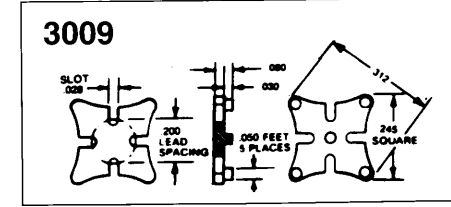
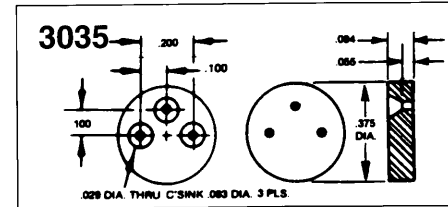
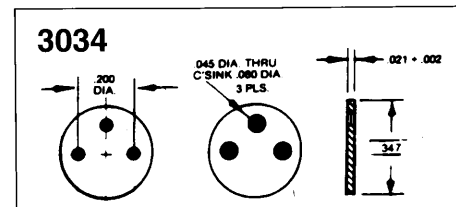
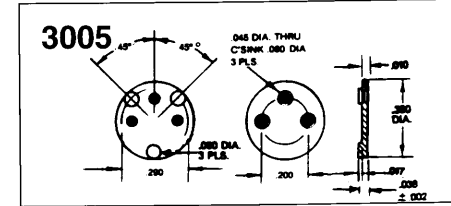
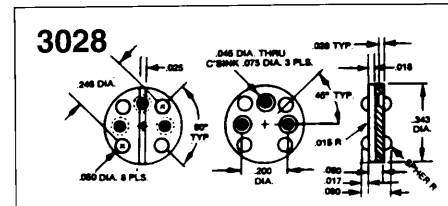
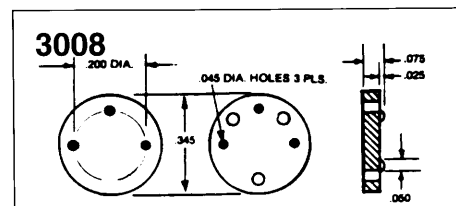
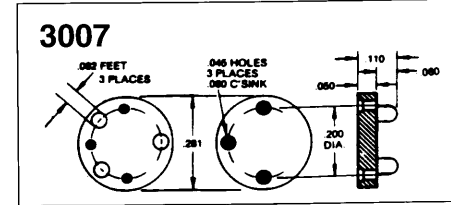
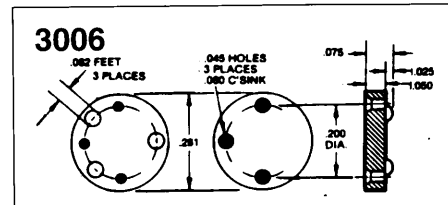
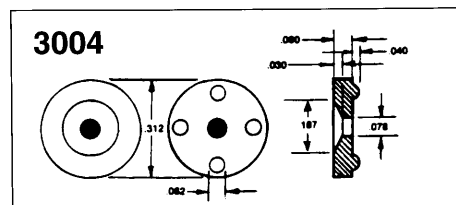



Montagescheiben für TO-5, Raster 5.08 mm

Fortsetzung

Achtung: alle Maße in am. inch = 25.4 mm

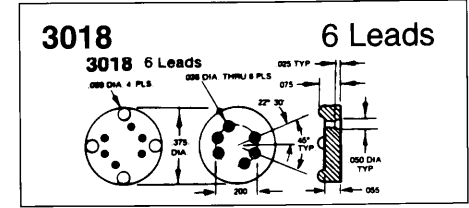
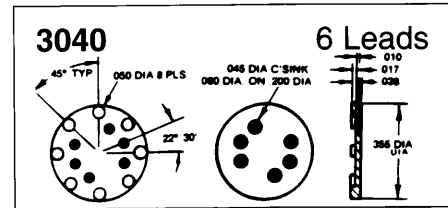
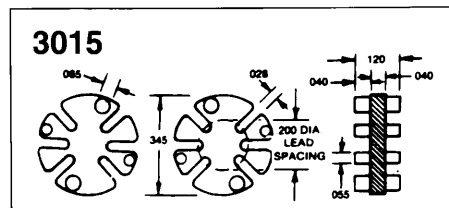
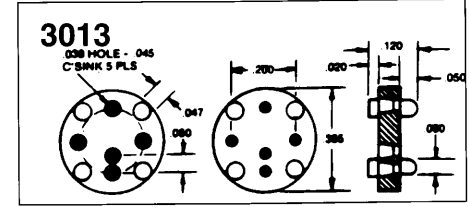
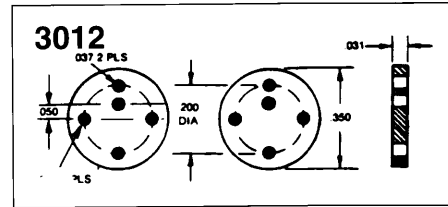
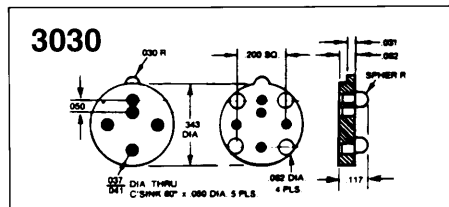
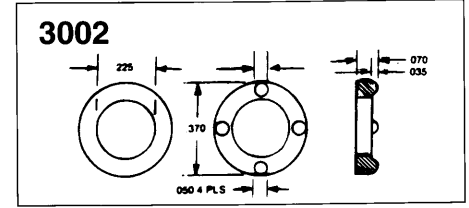
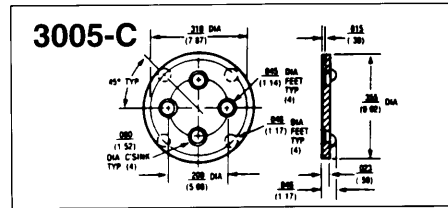
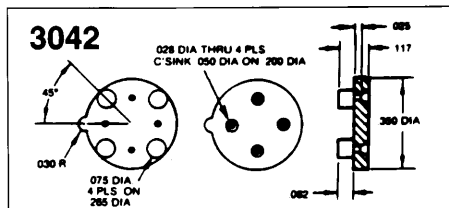
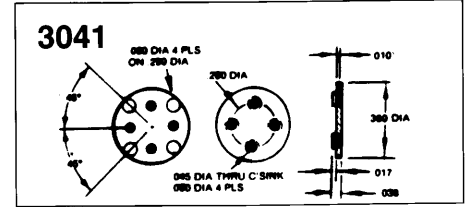
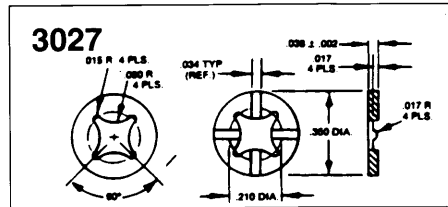
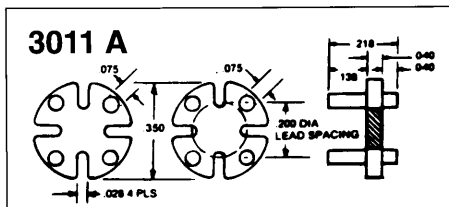
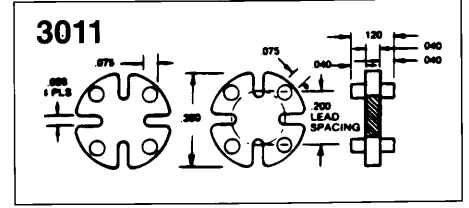
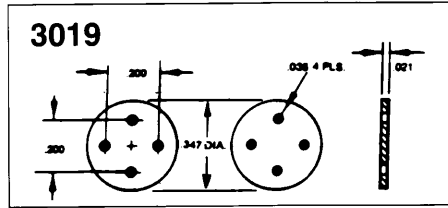
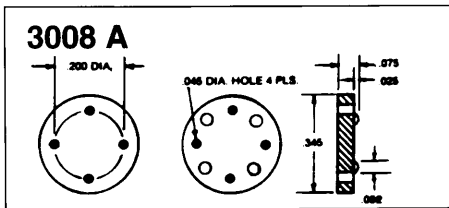

IC-Montagescheiben

Standardfarben Natur oder Weiß, Farbwünsche Rot oder Blau können berücksichtigt werden.

Achtung: alle Maße in am. inch = 25.4 mm

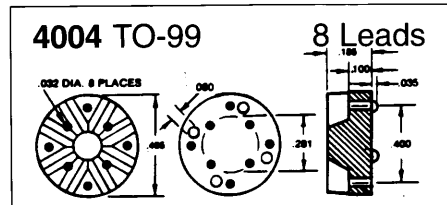
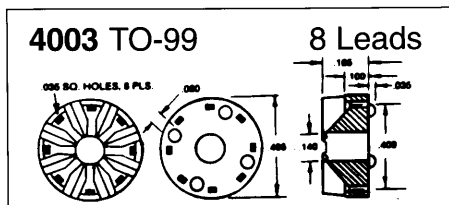
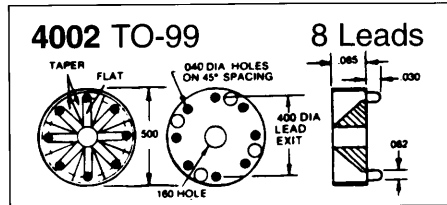
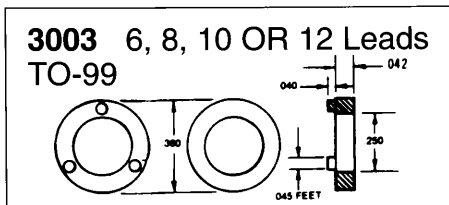

Type	Anz. d. Anschlüsse	Ø Innen mm	Dicke mm	Raster d. Anschlüsse	
				Eing.	Ausg.
3003	8/10/12	9.2	2.0	>5.08	>5.08
4002	8	12.7	2.9	>5.08	10.16
4003	8	12.6	5.6	>5.08	10.16
4004	8	12.6	5.6	>5.08	>7.11
4005	10	9.4	1.9	>5.08	>5.08
4008	12	9.4	2.9	>5.08	>5.8
4009	12	12.7	2.9	>5.08	10.16
4010	12	12.6	5.6	>5.08	>5.08
4015	10	-	2.3	>5.08	5.8
4016	10	12.6	6.7	5.8	10.16
4018A	8	12.7	7.0	>5.08	10.16
4021	8	9.5	2.03	>5.08	>7.62
4022	12	-	4.7	>5.08	7.62
4028	8	9.5	1.9	-	-
4029	8	9.5	2.4	-	-
4030	8	9.4	2.92	-	-
4031	10	9.5	2.4	-	-
4040	12	9.5	2.4	-	-
4041	8	9.3	2.03	>5.08	>5.08



IC-Montagescheiben

Fortsetzung

Achtung: alle Maße in am. inch = 25.4 mm

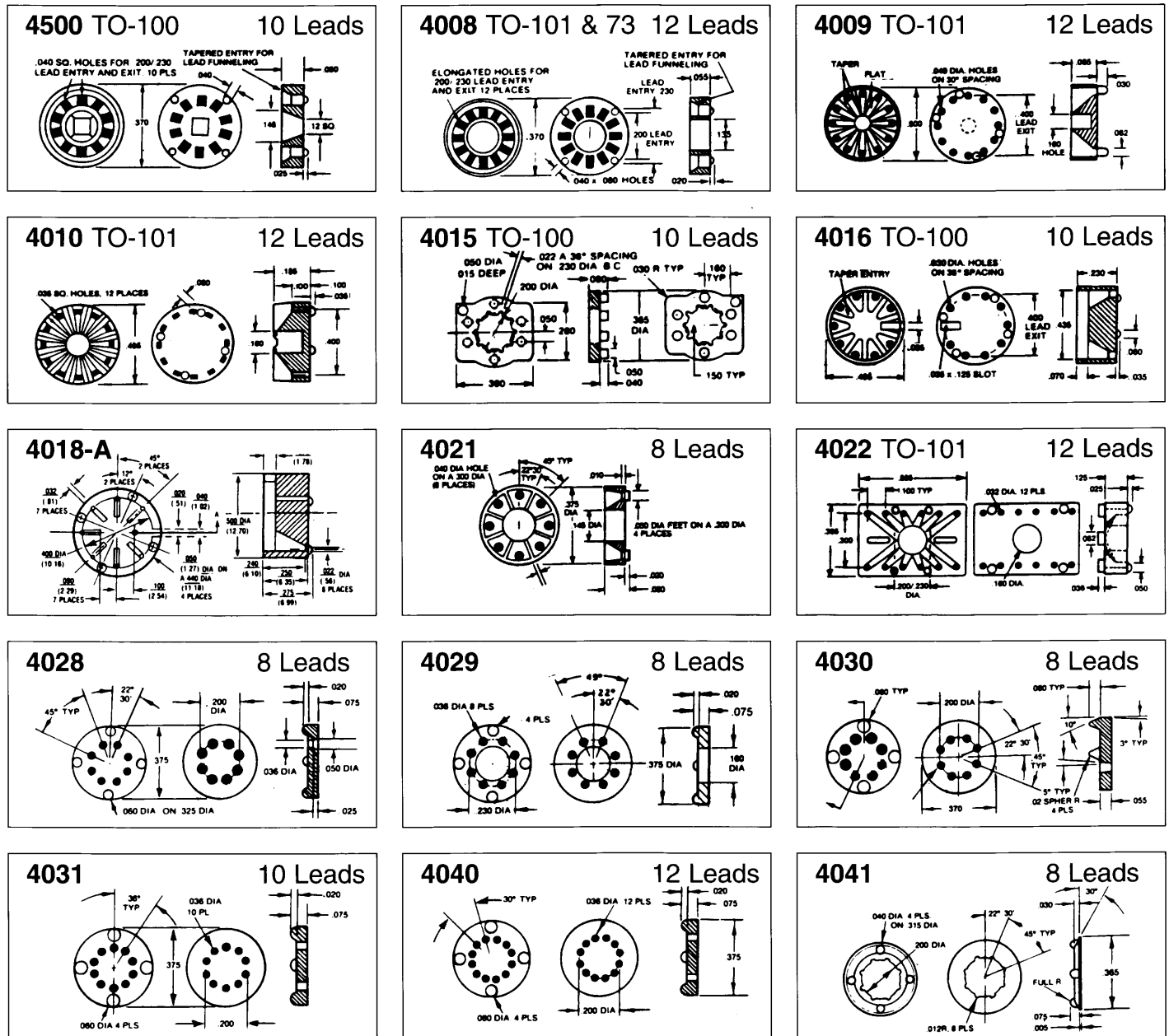

LED-Abstandshalter, zur genauen Distanzhaltung auf der Leiterplatte

Abstandsnoppen erlauben ein nachträgliches Reinigen der Leiterplatte!

Leichte Montage der LED durch angesenkte Löcher!

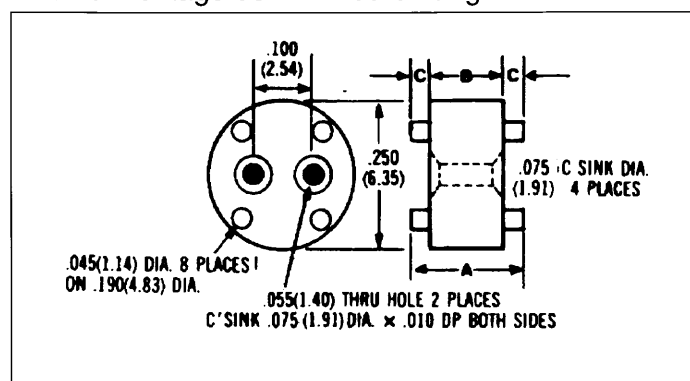

Type	A	B	C	Type	A	B	C
5900-050	1.27	0.76	0.25	5900-200A	5.08	3.81	0.64
5900-060	1.52	0.76	0.38	5900-210	5.33	3.81	0.76
5900-070	1.78	0.76	0.51	5900-220	5.59	3.81	0.89
5900-080	2.03	0.76	0.64	5900-230	5.84	3.81	1.02
5900-090	2.29	0.76	0.76	5900-240	6.10	3.81	1.14
5900-100	2.54	0.76	0.89	5900-250	6.35	3.81	1.27
5900-110	2.79	0.76	1.02	5900-260	6.60	3.81	1.40
5900-120	3.05	0.76	1.14	5900-270	6.86	3.81	1.52
5900-130	3.30	0.76	1.27	5900-280	7.11	3.81	1.65
5900-140	3.56	0.76	1.40	5900-290	7.37	3.81	1.78
5900-150	3.81	0.76	1.52	5900-300	7.62	3.81	1.91
5900-160	4.06	0.76	1.65	5900-310	7.87	3.81	2.03
5900-170	4.32	0.76	1.78	5900-320	8.13	3.81	2.16
5900-180	4.57	0.76	1.91	5900-330	8.38	3.81	2.29
5900-190	4.83	0.76	2.03	5900-340	8.64	3.81	2.41
5900-200	5.08	0.76	2.16	5900-350	8.89	3.81	2.54



LED-Abstandshalter, Distanzrollen zur genauen Distanzhaltung auf der Leiterplatte

Bestellung: Type 5 + XXX-Stellen für mm Längenangabe

Material: Nylon UL94 V-2

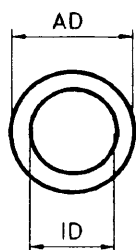

Höhe	I.D.	A.D.	Höhe	I.D.	A.D.
5XXXA	2.26	3.76	5XXXF	0.71	2.16
5XXXB	2.67	4.24	5XXXE	0.81	3.18
5XXXC	3.05	4.75	5XXXG	1.19	3.96
5XXXD	3.73	6.35	5XXXH	1.60	4.75

Type 7200B

Leistungsmodul mit UL System für TO-3

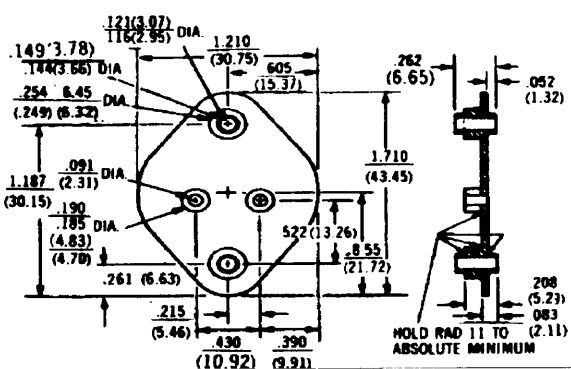

Isolatorplatten für TO-3

für Montagevereinfachung und Kostenersparnis

Maße (xx) in mm

7003-1 FOR TO-3 CASE

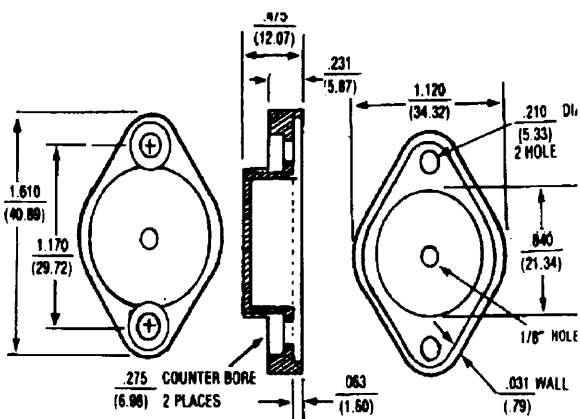

7004-C FOR TO-3 CASE

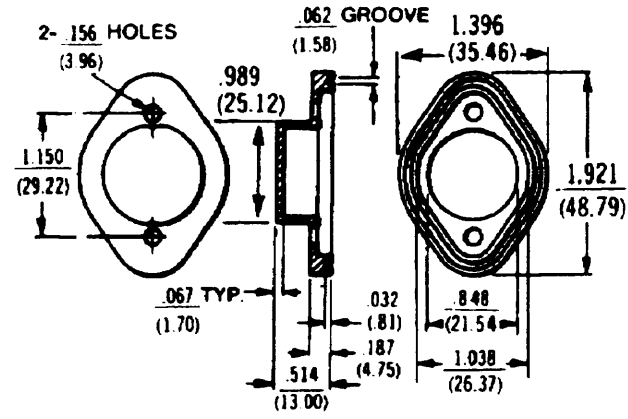

7004-UL FOR TO-3 CASE

For use with U.L. System

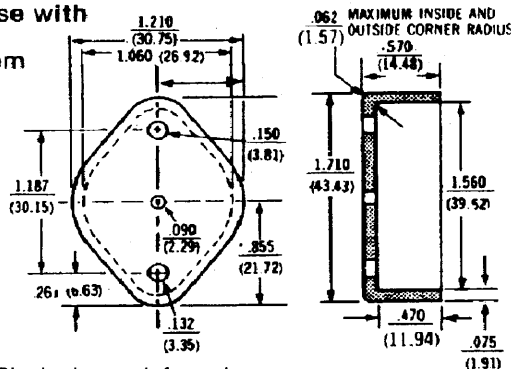

Material: Black glass reinforced nylon 6/6 U.L. Rating 94 V.O.

7203 FOR TO-3 CASE

7203 W.B. (with barrier)

